

MODEL 603 & AL603

STAMPED STRAIGHT BLADE SUPPLY WITH MULTI-LOUVER DAMPER

STANDARD INDUSTRY TOLERANCES APPLY. SPECIFICATIONS SUBJECT TO CHANGE WITHOUT NOTICE.

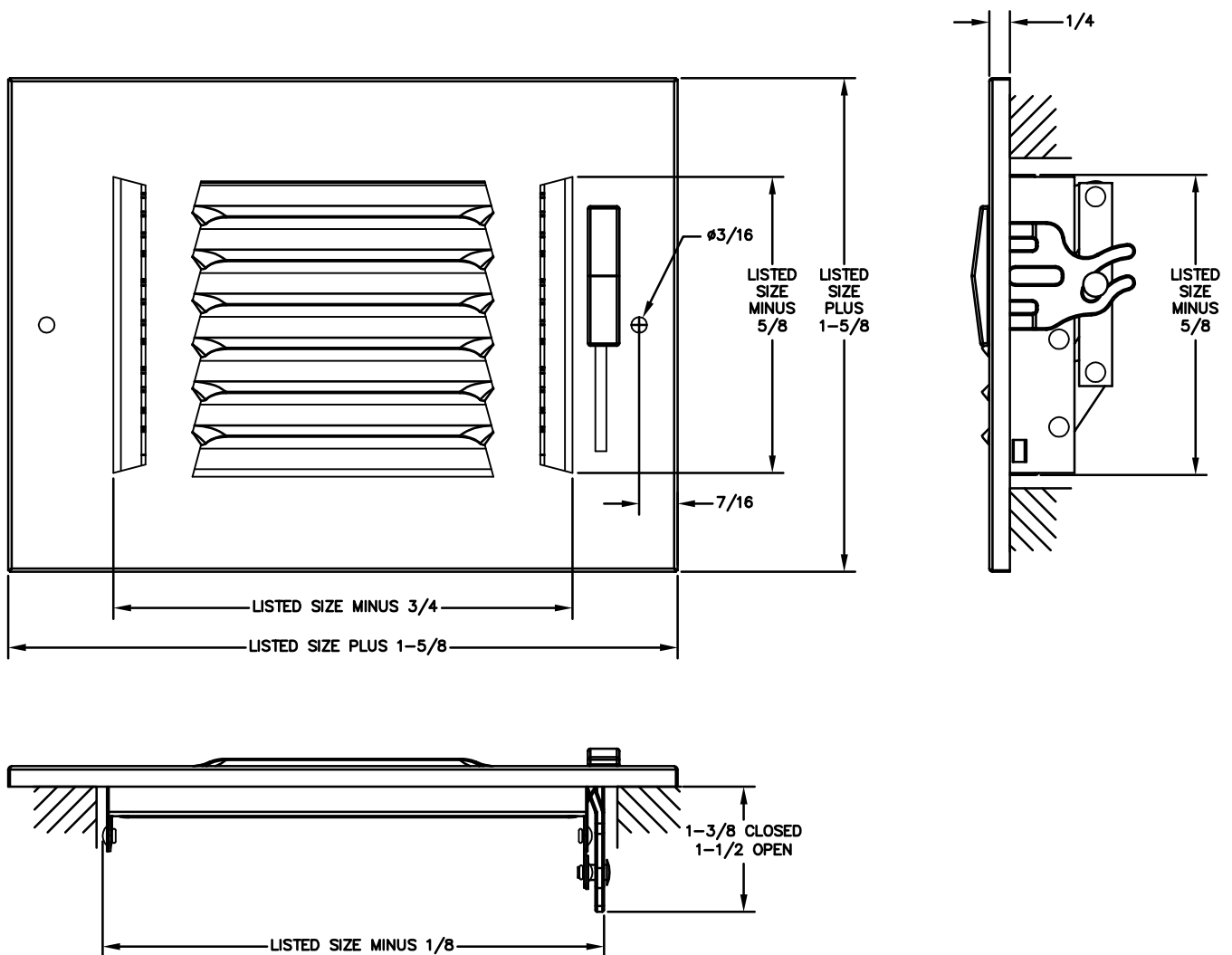

Model 603/AL603 is a stamped straight blade supply for ceiling or sidewall installation. The Model 603/AL603 features a 3-way air deflection pattern. The steel multi-louver damper assures equal air distribution over the diffuser face. Fins spaced at 1/2" and set at 45 degrees. Available in steel or aluminum. Standard finish is white.

PROJECT: _____
 ARCHITECT: _____
 ENGINEER: _____
 CONTRACTOR: _____
 LOCATION: _____

